

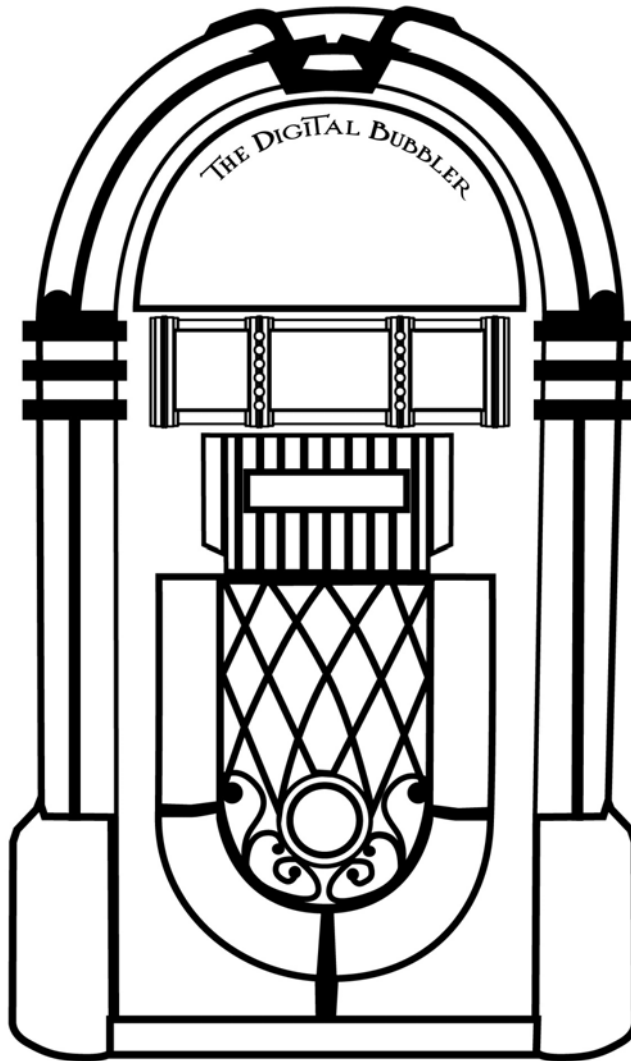

THE DIGITAL BUBBLER™

OWNER'S MANUAL



CHICAGO GAMING COMPANY

© Chicago Gaming Company 4616 W. 19th Street, Cicero, IL 60804 (800) 379-9776
(Rev.07)

DIGITAL BUBBLER™



Thank you for purchasing Chicago Gaming Company's *Digital Bubbler*. You can look forward to many hours of musical enjoyment. We strongly recommend that you follow the instructions and procedures as presented in this Owner's Manual and that it be read in its entirety before setting up your jukebox.

Table of Contents

1. Important Safety Instructions.....	2-3
2. Warranty Information.....	3
3. Navigating the Menus.....	4
4. CD Database and Untitled Albums.....	5
5. Mode Menu.....	6
6. Playlist Menu.....	7-8
7. Utilities Menu.....	9-16
8. Connecting to the Internet.....	17
9. Connecting External Speakers.....	18
10. AirClick.....	18
11. System Restore.....	19
12. Parts List.....	20-35
13. Wiring Diagram.....	36
14. FCC Compliance.....	37

1. IMPORTANT SAFETY INSTRUCTIONS

- Read these instructions.
- Keep these instructions.
- Heed all warnings.
- Follow all instructions.
- Do not use this apparatus near water.
- Clean only with a dry cloth.
- Do not block any ventilation openings. Install in accordance with manufacturer's instructions.
- Do not install near any heat sources such as radiators, heat registers, stoves, or other apparatus (including amplifiers) that produce heat.
- Do not defeat the safety purpose of the polarized or grounding-type plug. A polarized plug has two blades with one wider than the other. A grounding type plug has two blades and a third grounding prong. The wide blade and third prong are provided for your safety. If the provided plug does not fit into your outlet, consult an electrician for replacement of the obsolete outlet.
- Protect the power cord from being walked on or pinched, particularly at plugs, convenience receptacles and the point where they exit from the apparatus.
- Only use attachments/accessories specified from the manufacturer.
- Unplug this apparatus during lightning storms or when unused for long periods of time.
- Apparatus shall not be exposed to dripping or splashing and no objects filled with liquids, such as vases, shall be placed on the apparatus.
- Refer all servicing to qualified service personnel. Servicing is required when the apparatus has been damaged in any way, such as power supply cord or plug is damaged, liquid has been spilled or objects have fallen into the apparatus, the apparatus has been exposed to rain or moisture, does not operate normally, or has been dropped.

 <p>THE LIGHTNING FLASH AND ARROWHEAD WITHIN THE TRIANGLE IS A WARNING SIGN ALERTING YOU OF "DANGEROUS VOLTAGE" INSIDE THE PRODUCT.</p>	 <p>CAUTION: TO REDUCE THE RISK OF ELECTRIC SHOCK, DO NOT OPEN FRONT DOOR. NO USER SERVICEABLE PARTS INSIDE. REFER SERVICING TO QUALIFIED SERVICE PERSONNEL.</p>	 <p>THE EXCLAMATION POINT WITHIN THE TRIANGLE IS A WARNING SIGN ALERTING YOU OF IMPORTANT INSTRUCTIONS ACCOMPANYING THE PRODUCT.</p>
<p>SEE MARKINGS ON PRODUCT</p>		

CAUTION: Shock hazard if instructions are not followed.

- **WARNING:** To reduce the risk of fire or electric shock, do not expose your system to rain or moisture.
- **WARNING:** An apparatus with Class I construction shall be connected to a main socket outlet with a protective earthing connection.
- **WARNING:** Bubble Tubes contain Methylene Chloride. Harmful if swallowed, inhaled or absorbed through skin. Causes irritation to the skin, eyes and respiratory tract.
- Be sure to disconnect the power cable before working on the machine.
- Be sure to use fuses that meet the specified rating. (5A, 220V Quick-blow). Using fuses exceeding the specified rating can cause a fire and electrical shock.
- **CAUTION:** The jukebox's monitor is a source of high voltage. Be **EXTREMELY CAREFUL** when working near it; high voltage charges can still be present even after you've unplugged the unit. **Have a qualified technician perform a monitor repair.**
- **CAUTION:** Battery May Explode If Mistreated. Do Not Recharge, Disassemble Or Dispose Of In Fire.
- **CAUTION:** Danger of explosion if battery is incorrectly replaced. Replace only with the same or equivalent type.
- Replace Battery with Matsushita, Type CR2032, Only. Us Of Another battery May Present A Risk Of Fire Or Explosion.
- Optimum operating environment is between 50-105° Fahrenheit.
- Use with only 115 volts ~ 60Hz
- We recommend using a surge suppresser or UPS (Uninterruptible Power Supply) to safeguard the jukebox from abrupt power spikes or losses

2. WARRANTY INFORMATION

The Digital Bubbler is warranted against manufacturing defects for 180 days. After that we will provide free telephone support. If at some point you require warranty service, contact Chicago Gaming at (800) 379-9776. Ask for technical support.

3. Navigating the Menus



3.1 Vol Up-This button turns the volume up.

3.2 Vol Down-This button turns the volume down.

3.3 Pause/Resume-This button pauses the current song. Pressing it again resumes play.

3.4 Mode- This button opens the **Mode** Menu.

3.5 Playlists- This button opens the **Playlist** Menu.

3.6 Utilities- This button opens the **Utilities** Menu.

3.7 Menu-This button is used to go to the previous or top menu.

3.8 Select-This button is used to make selections and proceed through the menus.

3.9 Page Up-This button moves the cursor up multiple lines.

3.10 Up-This button moves the cursor up one line.

3.11 Down-This button moves the cursor down one line.

3.12 Page Down- This button moves the cursor down multiple lines.

The power switch is located on the top center back of the machine



It is used to turn the machine on and off

4. CD Database and Untitled Albums

The majority of CDs do not contain text data on the artist name, album name and track names. The Digital Bubbler contains a text database of 2,500,000 albums. This database allows the system to include album information even when the jukebox is not connected to the internet.

This database is installed in the jukebox at the date of manufacture; therefore any albums released after the latest database update will not be recognized by the local database.

If you are ripping an album to the jukebox, and the name of the album does not appear in the list, choose Rip As Untitled. After the CD is ripped, you can either enter a title for the album through Edit Untitled Albums, or you can connect to the updated Internet Database (via telephone line or ethernet connection) to automatically enter the album information for all untitled albums you have copied to your jukebox.

Alternately, you can leave The Digital Bubbler connected to the internet through your high speed connection and the jukebox will always use the current, updated Internet Database.

See **section 7.1.i** on **page 10** for information on Editing Untitled Albums, and check **section 7.1.iv** on **page 11** for information on Processing Untitled Albums With Internet

5. Mode Menu

Pressing the **Mode** button opens the Mode Menu. This menu allows the user to sort music by Artist, Album Name or Track Name. This menu also allows you to turn Shuffle or Jukebox Mode on.

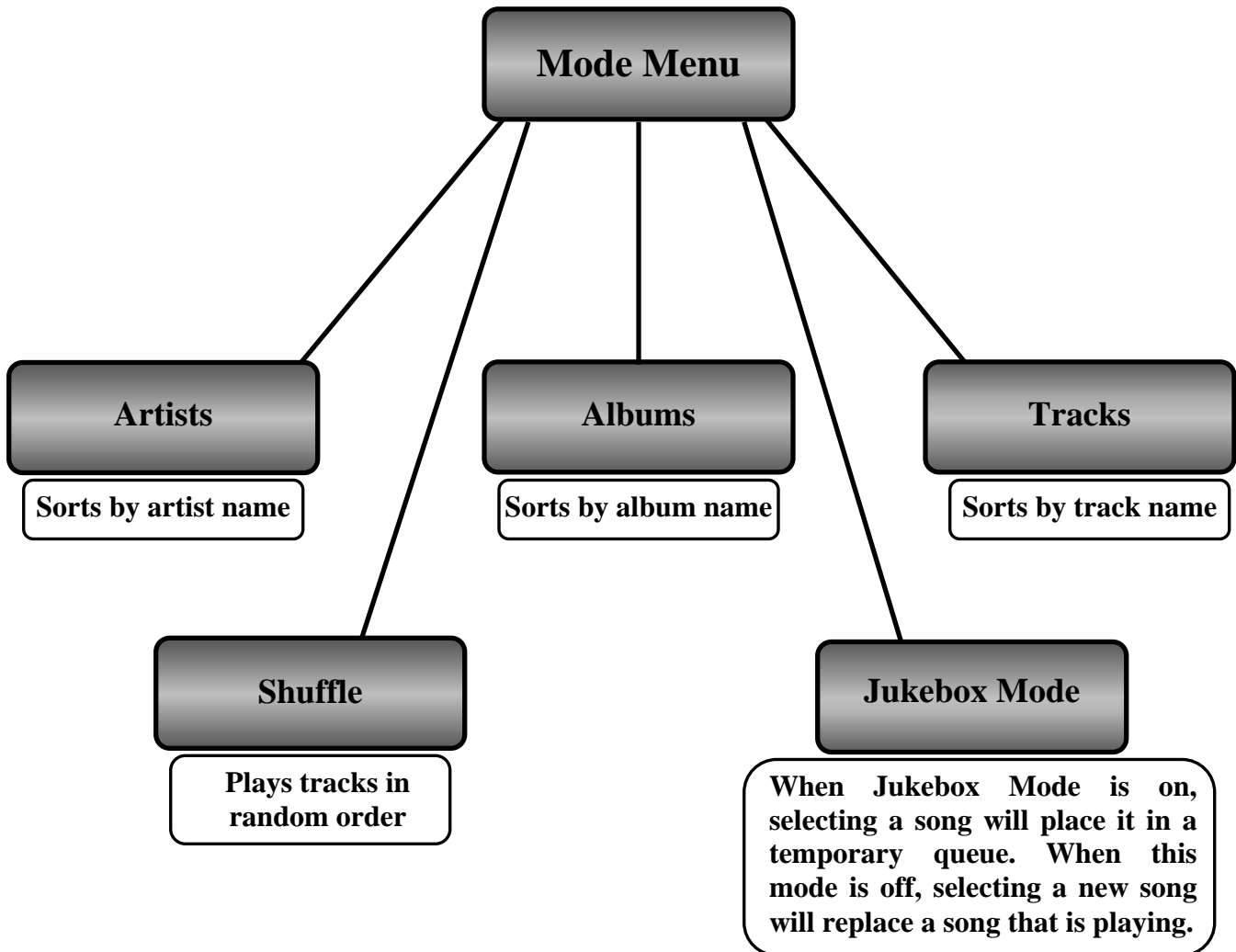

6. Playlist Menu

Pressing the **Playlist** button opens the Playlist Menu. This is used to create and manage saved playlists.



6.1 Add Playlist

This option allows the user to create a new playlist. While adding songs to a playlist, the tracks are sorted according to which mode you are in. Select the track with the **Select** button and go back with the **Menu** button. To exit and save, press **Playlist**. Upon saving, the playlist will be given a generic name. To change the name, choose Edit Playlist Name.



6.2 Delete Playlist

Selecting Delete Playlist from the Playlist Menu allows the user to erase unwanted playlists. Using the **Up** and **Down** buttons, select the playlist to be deleted.



6.3 Edit Playlist Name

To edit a playlist name, select a playlist from the menu using **Up**, **Down**, and **Select**.

Use **Up** and **Down** to change letters. **Page Up** and **Page Down** move six letters at a time. Use **Select** to move the cursor forward and **Menu** to save changes.



6.4 Select Playlist

Use this option to start a playlist that has already been created. Use **Up** and **Down** to navigate and **Select** to begin playing.



7. Utilities Menu

Pressing the **Utilities** button opens the **Utilities** Menu. This menu allows the user to manage albums, adjust settings, perform diagnostics, and rip CDs.

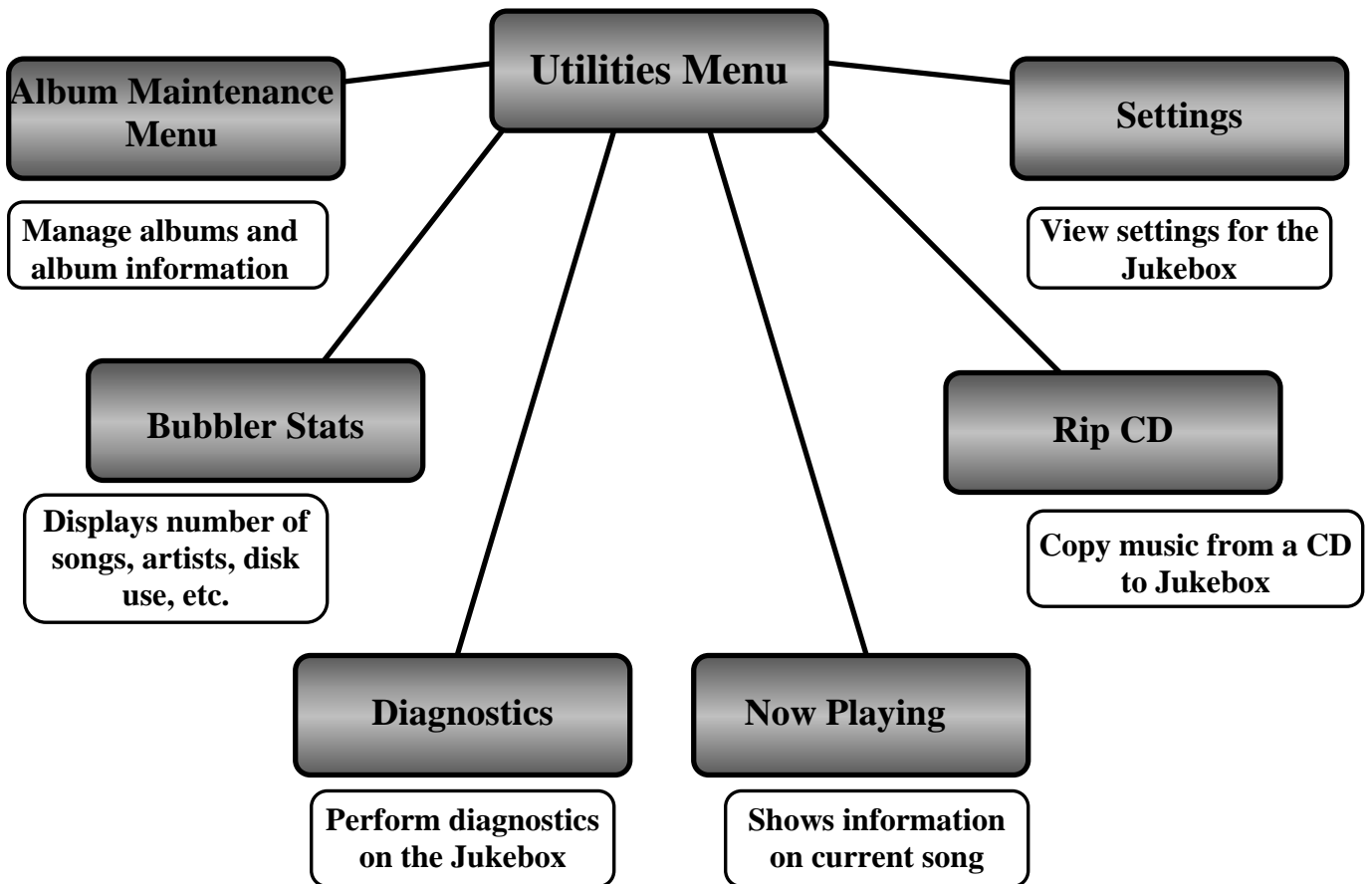

7.1 Album Maintenance Menu

The Album Maintenance Menu allows the user to manage album names, merge artists, and access the internet to update untitled albums.



7.1.i Edit Untitled Album

This option allows the user to add information for an untitled album. Select the album to be edited. Use **Up** and **Down** to change letters, **Menu** to go back, and **Select** to advance the cursor. See **section 4** on **page 5** for more information on untitled albums.



7.1.ii Delete Albums

This option allows the user to delete an entire album from The Digital Bubbler. After selecting Delete Albums, choose the album to be deleted. The albums are organized alphabetically by album name.



7.1.iii Merge Artists

If albums of a single artist are listed under multiple variations of a single artist name (i.e. Beatles and The Beatles), the user may combine the multiple instances into one common name. After selecting Merge Artist, choose the name of the surviving artist, then choose the name to be merged into the surviving artist name.

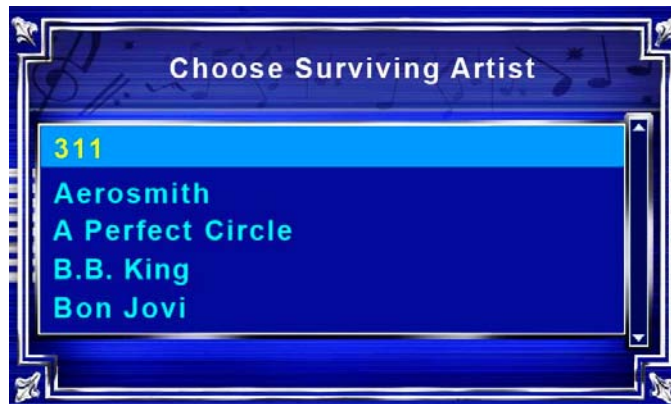

7.1.iv Process Untitled Albums With Internet

If a CD does not appear from the local database, the jukebox can be connected to the internet to search for album information. Either an ethernet cable or dialup modem can be used. Check **section 8** on **page 17** for more information on how to connect to the Internet. *Note: You do not need an existing Internet account to use the dialup modem; you just need a working telephone line.*



7.2 Bubbler Stats

Select Bubbler Stats to view current status of the Digital Bubbler. The current software version numbers can be found in a table towards the bottom of the screen. Descriptions of the stats are shown below.

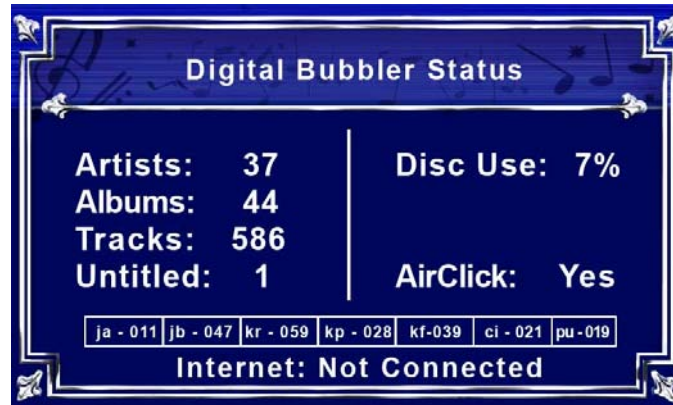

Artists: Number of different artists copied to the jukebox.

Albums: Total number of albums copied to the jukebox.

Tracks: Total number of songs copied to the jukebox.

Untitled: Number of albums without titles.

Disk Use: Percent of hard drive currently used.

Air Click*: Displays whether the AirClick is connected.

Internet: Either Connected or Not Connected to the internet.

ja-011	jb-054	kr-059	kp-028	kf-039	ci-021	pu-019
---------------	---------------	---------------	---------------	---------------	---------------	---------------

These boxes contain information on the various software version numbers

7.3 Diagnostics

The Diagnostics Menu accesses tests of button functionality, AirClick connectivity, and a log of the modem activity.



7.3.i Switch Test

The Switch Test allows the user to test that the buttons are working properly. The description of the button pressed should appear in the box on the display. Press **Menu** three times to exit the Switch Test.



7.3.ii AirClick Test

The Digital Bubbler supports the Griffin AirClick USB. This tests the functionality of the AirClick device. Like the Switch Test, pressing a button on the AirClick should display the button in the box. AirClick connects to a USB port, which is located on the back panel of the jukebox. See **section 10** on **page 18** for more information on the AirClick.



7.3.iii Modem Dialup Log

This is a log of attempted connections to the internet through the dial up modem, which is used to diagnose modem related issues. Use **Up**, **Down**, **Page Up** and **Page Down** to navigate.



7.4 Now Playing

Choosing Now Playing shows a screen that displays information about the song that is currently playing.



7.5 Rip CD



7.5.i Rip CD

To transfer a CD to the Digital Bubbler, Choose Rip CD from the **Utilities** Menu. The jukebox will check the CD against the database to find the album information. If more than one album title is returned, choose the correct name using the **Up**, **Down** and **Select** buttons. If the name of the album in the jukebox does not appear, choose Rip As Untitled CD.

The album information can either be entered manually, or Process Untitled Albums With Internet can be used. Instructions for processing untitled albums can be found in the Albums Maintenance Menu on **page 8**.

7.5.ii Eject CD/Open Tray

This selection is an alternative to pressing the Open Tray button on the right side of the CD drive.

7.6 Settings

The Settings Menu lets you change your ISP Phone Number, Bass and Treble levels, and turn Main Channel and J-Pod Channel On or Off.



7.6.i Bass & Treble Control

Bass and Treble Control can be found in the **Utilities** Menu, listed under Settings. **Page Up** and **Page Down** control bass, while **Up** and **Down** control treble. Both bass and treble can be changed from -18 db to +18 db. Press **Menu** to exit and save.



7.6.ii ISP Phone Number

This menu allows you to change the number the modem will dial to connect to the internet. Press **Up** and **Down** to change the number, **Select** to move to the next number, and **Menu** to exit and save. To find the closest number to your location, go to page 35 to search by state, or visit the following website and enter the first six digits of your telephone number: <https://myaccount.earthlink.net/cam/accessnumber.jsp>



7.6.iii JPOD Channel

An external audio device, such as an MP3 player, can be played through The Digital Bubbler. The line-in jack can be found just inside the CD Door, on the right side.

This setting toggles the line in **ON** or **OFF**. When connecting an external audio device, be sure to turn JPOD Channel ON.

7.6.iv Main Channel

This setting toggles the Main Channel ON or OFF. If the Main Channel is OFF, audio will only be played through the Line-In.

8. Connecting To the Internet Database

Information on new albums is not included in the local database. You can connect to the internet database through either the dialup modem or an existing broadband line. You do not need an internet account to use the dialup modem.

8.1 Broadband Connection

To connect The Digital Bubbler using broadband, connect an ethernet cable from your modem or router to the ethernet jack on the back of the jukebox. You must have broadband service to update using this method. The Digital Bubbler may need up to a minute to recognize the connection. To check internet connectivity, choose Bubbler Stats from the **Utilities** Menu. You can leave the jukebox connected to the internet at all times. New CDs ripped while connected will use the internet database, rather than the local database, to collect album information.

8.2 Dialup Connection

Digital Bubbler has an optional dialup modem that can be used to connect to the internet database. The first step is finding the access number closest to your location. Turn to **pages 35-63**, or visit Earthlink's website at <https://myaccount.earthlink.net/cam/accessnumber.jsp>. Refer to **section 7.6.ii** for information on entering your access number.

After this is complete, simply run a telephone line from a wall jack to the jukebox modem jack. Press **Utilities**, choose Album Maintenance, and Process Untitled Albums Using Internet. When you are asked if you want to connect using the modem, choose 'YES' and the jukebox will automatically dial, connect and download album information for your untitled albums. The modem will disconnect when the download is complete.

Summary: Find your access number, enter access number in **Utilities** => Settings => ISP Phone Number, connect phone line and access database through **Utilities** => Album Maintenance => Process Untitled Albums With Internet.

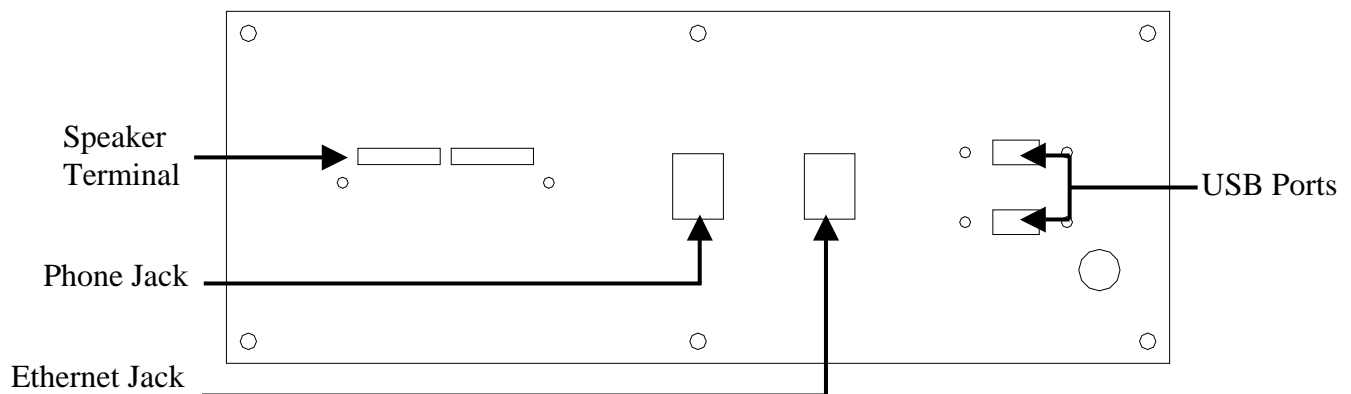

9. Connecting External Speakers

The Digital Bubbler supports **two 8 Ohm** external speakers. The speaker terminal can be found on the back panel, next to the ethernet and phone line jacks. To attach the speakers, run the wire from the speaker to the jukebox. Press on the colored release tab and push the end of the corresponding wire into the terminal. Releasing this tab will hold the wire in place.

- **Be sure to connect the red terminal on the speaker to the red terminal on the jukebox. Do not connect red to black!**
- **If your speaker wire is not colored, make sure you connect the same wire to the same color on both the speaker and the jukebox**
- **Use only 8 ohm speakers**
- **Do not add more than one speaker per channel**

10. AirClick

The Digital Bubbler is compatible with the Griffin AirClick. This can be used to remotely Pause, Skip Forward, Skip Backward or adjust the volume.



Connect the AirClick to a USB port on the back panel before turning the jukebox ON. After the jukebox boots, press **Utilities** to access Diagnostics. Select AirClick Test to make sure the AirClick is functioning properly. Pressing a button on the remote should cause its function to appear on The Digital Bubbler's display.

Griffin AirClick USB can be purchased at www.griffintechology.com

The Manufacturer Part Number is 4023-ACUSB.

11. System Restore

To perform a system restore

- 1) While The Digital Bubbler is turned on, open the disc tray and insert the system restore DVD
- 2) Turn the power off and wait for 10 seconds
- 3) Turn the power on, and wait for the JB Live! Menu to load. This will take slightly longer than normal

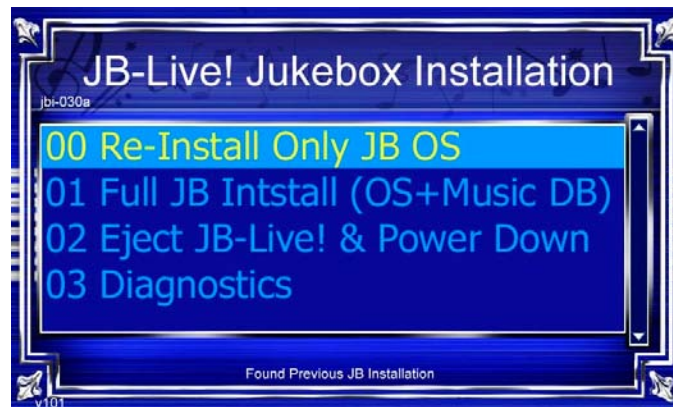

11.00 Re-Install Only JB OS

This option allows you to reinstall the jukebox operating system without losing any Albums or Playlists. Highlight this option and press **Select** to start reinstallation. This will only work on a hard drive that already has the software installed.

11.01 Full JB Install (OS + Music DB)

This option will reformat the hard drive and completely install the operating system and music database. Highlight this option, press select, and follow the on-screen instructions to begin software installation. This operation will reinstall software on the hard drive or format and install software on a new hard drive.

11.02 EJECT JB-Live! & Power Down





After you have reinstalled the JB OS or performed a full installation, you must select this option to eject the DVD before you power down. Or, if you accidentally boot with the DVD, this option allows you to eject the DVD and power down without reinstalling any software.



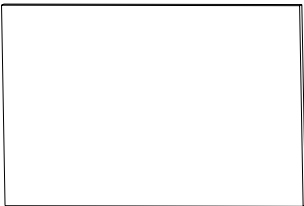

11.03 Diagnostics

Selecting this option will open the Button Test. Pressing any button should make the name of that button appear on the screen. Press **Menu** three times to exit.



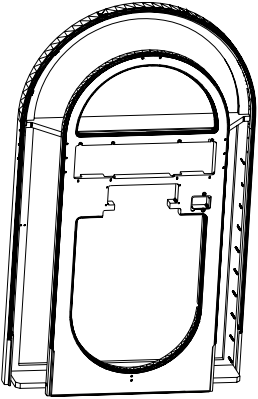
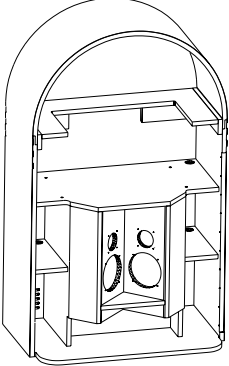
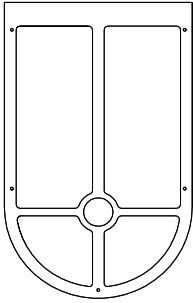

12. Parts List



Part Picture	Part Number	Part Name	Qty.
	015-ART-ARTWIN	Door Window Art Panel	1
	015-ART-CDDOOR	CD Door Plexi	1
	015-ART-CLRCCFL	CCFL Color Gel	2
	015-ART-CLRTUBE	Color Tube Insert	2
	015-ART-COINPLX	Coin Entry Plexi	1
	015-ART-COLORS	Color Cone	2
	015-ART-DWINDOW	Door Window Screened "Digital Bubbler"	1
	015-ART-GARTCVR	Grill Art Cover	1
	015-ART-GRLSTAR	Grill Star Art Plexi	1

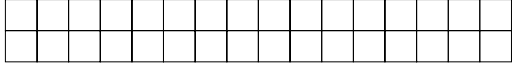

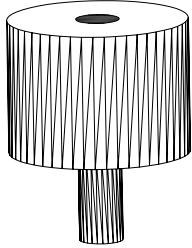
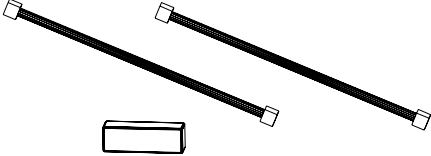
Part Picture	Part Number	Part Name	Qty.
	015-ART-LCDPLEX	LCD Display Glass	1
	015-ART-TITLEFT	Title Plexi Left	1
	015-ART-TITLERT	Title Plexi Right	1
	015-ART-WTUNEL	Door Window Tunnel	1
	015-CBL-POWBUTN	Power Button Cable	1
	015-CBL-12VDOOR	Door +12Volt Cable	1
	015-CBL-BUBHEAT	Bubble Heater Cable	4
	015-CBL-AMPBUTS	Amp – Buttons Cable	1
	015-CBL-AMPCROS	Amp Crossover Cable	1
	015-CBL-AMPWR	Amp Power Cable	1
	015-CBL-AMPSERL	Serial – Amp Cable	1
	015-CBL-DOORAC	Door AC Cable	1
	015-CBL-LCDPWR	LCD Cable	1
	015-CBL-SPEAKLF	Speaker Cable Left	1
	015-CBL-SPEAKRT	Speaker Cable Right	1
	015-CBL-LINEIN	Line In Jack	1
	015-CBL-SWPCB	Switch PCB Harness	1
	015-CBL-POWER	Power Wire Harness	1
	015-CBL-4FLTFLX	Molex-Cable Flat Flex 4" .50MM	1
	015-CBL-USB0402	USB to Motherboard Adapter	2
	000-CBL-3USBAB	USB A-M to B-M 3' long	1
	000-CBL-6USBAB	6' USB Cable A-M to B-M white	1
	000-CBL-2ENETC5	2' Internal Ethernet Cable	1
	000-CBL-6PWR18G	6' Power Cord 18 Gauge	1
	000-CBL-IDE133F	IDE 133 Flat Cable 18" 3 Connector	2

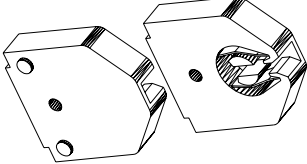
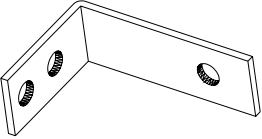
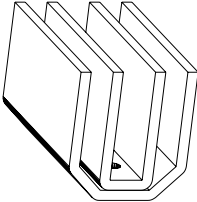

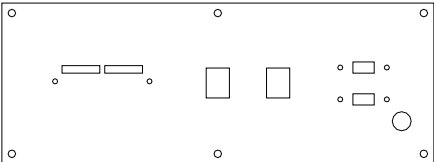
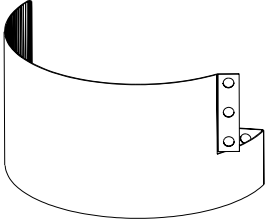
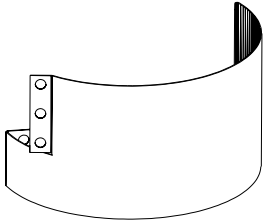
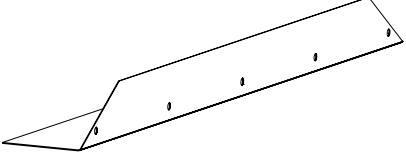
Part Picture	Part Number	Part Name	Qty.
	015-CCC-FRTDOOR	Front Door	1
	015-CCC-MAINCAB	Main Cabinet	1
	015-CCC-SPKPANL	Speaker Panel	1
	000-CTR-ENETCPL	Cat-4 Ethernet Coupler (Bigger opening)	1
	000-CTR-PHONCPL	Telephone Line Coupler (Smaller opening)	1
	000-ELE-256DDR	RAM 256 DDR (DDR266)	1

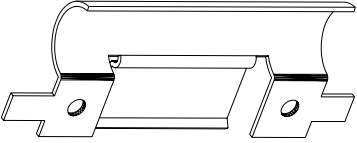
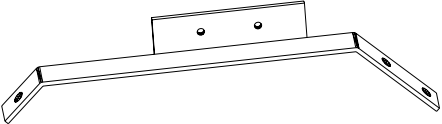
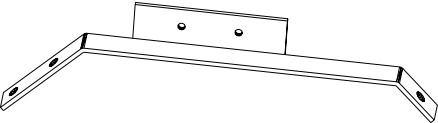
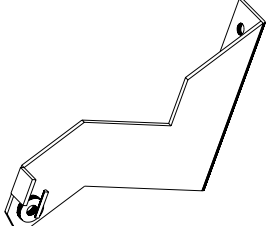
Part Picture	Part Number	Part Name	Qty.
	000-ELE-BALLAST	Florescent Electronic Ballast	2
	000-ELE-DVDDRIV	Sony DVD Drive Black DDU1615	1
	000-ELE-HD250GB	Western Digital 250GB Hard Drive	1
	015-ELE-JAMPPII	Audio Amp	1
	015-ELE-PSUP460	Power Supply	1
	000-ELE-ML8000	VIA SBC	1

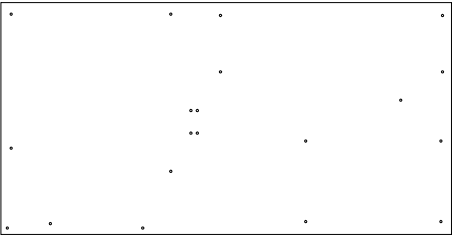
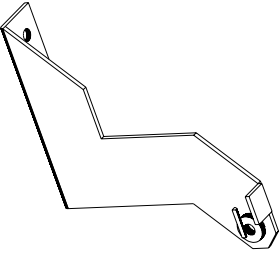
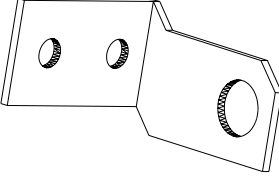
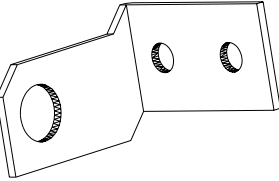
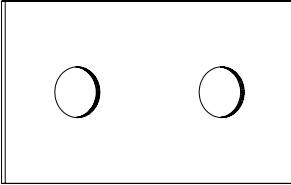
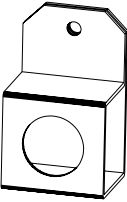

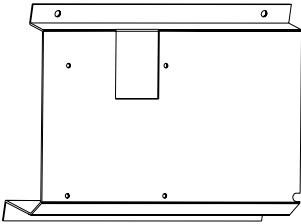
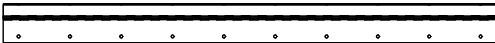

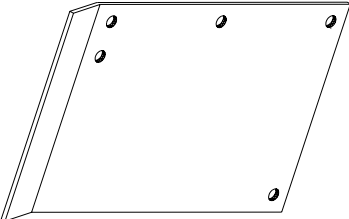
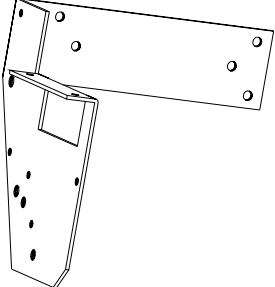
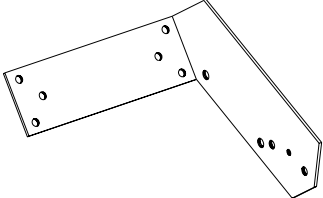
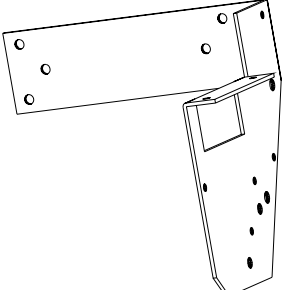
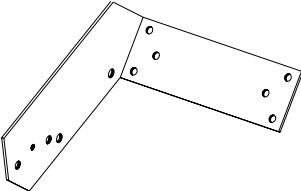
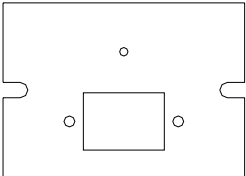
Part Picture	Part Number	Part Name	Qty.
	000-ELE-MODEMSL	Modem (smartlink, winmodem)	1
	015-GLS-HMIRROR	Mirrors For Side of Cabinet	
	015-HDW-12GRILL	12" Woofer Grill	1
	000-HDW-SMOUNT	Shock Mounts	4
	000-LMP-12CCFL	CCFL Tubes	2
	000-LMP-F20T12C	Florescent Lamp	2
	000-LMS-042050	Florescent Lamp Socket	2
	015-MLS-AGLBRKT	Angle Bracket	4
	015-MLS-AMPHEAT	Power Amp Heat Sink	1

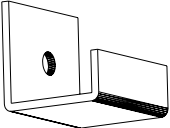

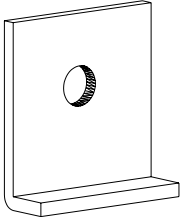
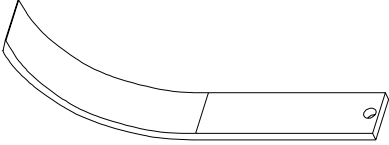
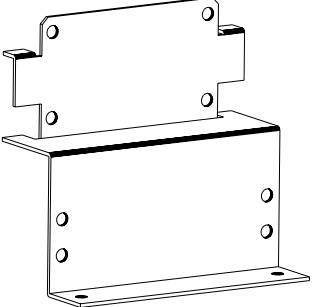
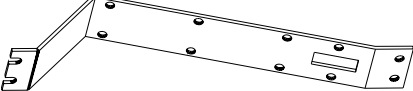
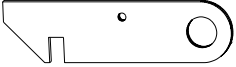
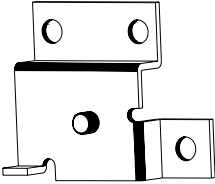
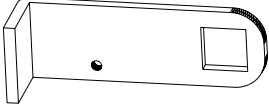
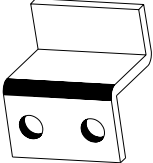
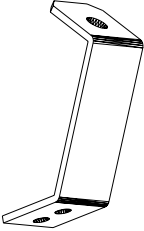
Part Picture	Part Number	Part Name	Qty.
	015-MLS-BAKPANL	Back Panel	1
	015-MLS-BASCNLF	Base Trim Corner Left	1
	015-MLS-BASCNRT	Base Trim Corner Right	1
	015-MLS-BASEFR	Base Front Trim	1
	015-MLS-BASELF	Base Side Left	1
	015-MLS-BASERT	Base Side Right	1
	015-MLS-BUBHEAT	Bubble Tube Heater	16
	015-MLS-BUBMTGL	Bubble Mount Left Bracket	4
	015-MLS-BUBMTGR	Bubble Mount Right Bracket	4
	015-MLS-CDBRKTL	CD Door Bracket Left	1

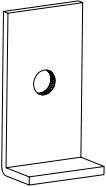
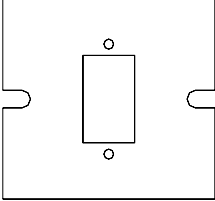
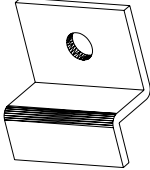
Part Picture	Part Number	Part Name	Qty.
	015-MLS-ELECPLT	Electronics Mounting Plate	1
	015-MLS-CDBRKTR	CD Door Bracket Right	1
	015-MLS-CDPIVTL	CD Door Pivot Left	1
	015-MLS-CDPIVTR	CD Door Pivot Right	1
	015-MLS-CDSPACR	CD Door Spacer	2
	015-MLS-CFBALST	CCFL Inverter Mount	1
	015-MLS-CFLAMP	CCFL Lamp Mount Bracket	2
	015-MLS-CLCDMNT	LCD Mount Bracket	1
	015-MLS-DHING2	Door Hinge	1

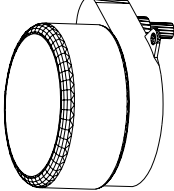

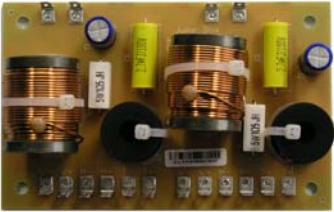
Part Picture	Part Number	Part Name	Qty.
	015-MLS-DSKID	Door Skid	1
	015-MLS-FLMPLFL	F. Lamp Mount Left Lower	1
	015-MLS-FLMPLFU	F. Lamp Mount Left Upper	1
	015-MLS-FLMPRTL	F. Lamp Mount Right Lower	1
	015-MLS-FLMPRTU	F. Lamp Mount Right Upper	1
	000-MLS-FUSPLT	Power Inlet Plate	1
	015-MLS-GLSBKRT	Display Glass Retainer	6
	015-MLS-GRILCLM	Grill Clamp	10

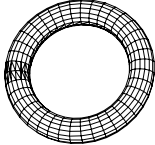
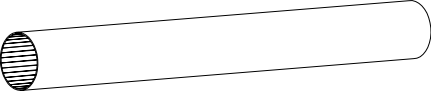
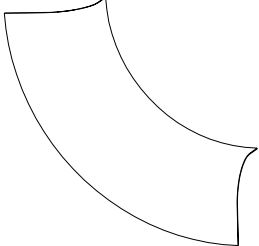
Part Picture	Part Number	Part Name	Qty.
	015-MLS-GRILCLP	Woofer Grill Clip	4
	015-MLS-GRILTRM	Inner Grill Trim Bracket	2
	015-MLS-HDDBRK	CD & HDD Mount Bracket	2
	015-MLS-KEYBRKT	Keyboard Mount Bracket	2
	015-MLS-LCKBAR	Lock Bar	1
	015-MLS-LCKPIVT	Lock Pivot	1
	015-MLS-LCKRELS	Lock Release	1
	015-MLS-LCKSTRK	Lock Strike	1
	015-MLS-LINEIN	Line In Bracket	1

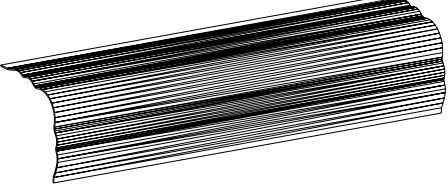
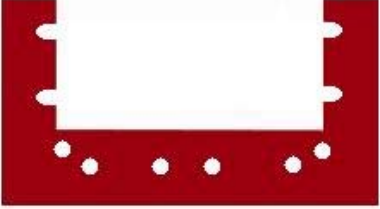
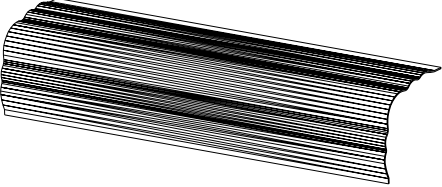
Part Picture	Part Number	Part Name	Qty.
	015-MLS-PLSBRKT	Plastic Retainer	16
	000-MLS-PWRPLT2	Power Switch Plate for Chily Switch	1
	015-MLS-WINCLIP	Window Clip	4
	015-MON-LCD8INC	LCD Display	1
	015-MTR-A224LC5	Synchron 110V, 60Hz, 10 RPM Motor w/ .175 flatted shaft	2
	015-PCB-BUTTONS	Button Board Assembly	1
	015-PCB-CROSOVR	Crossover	1

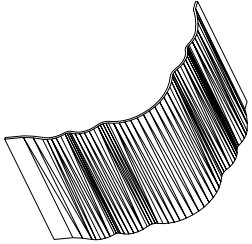
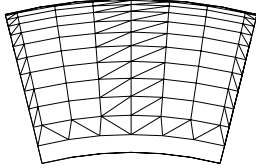
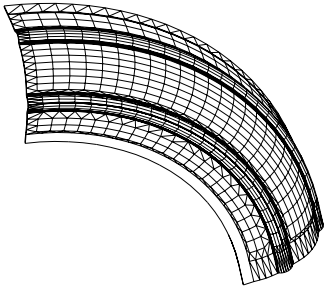
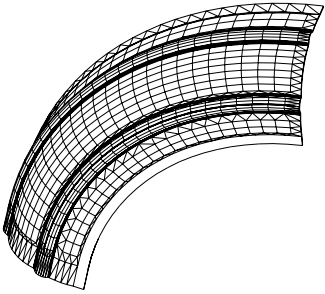
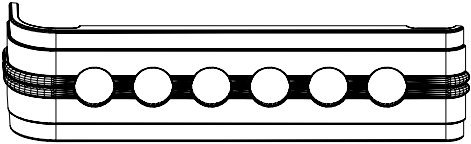
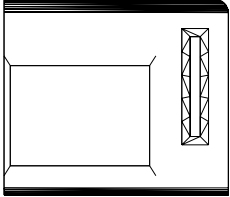
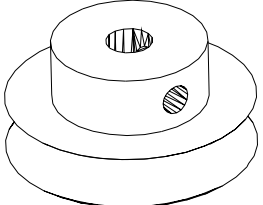

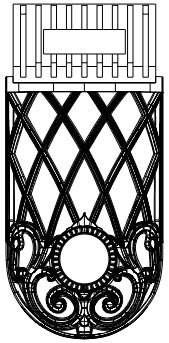
Part Picture	Part Number	Part Name	Qty.
	015-PCB-LCDINT2	LCD to USB Interface	1
	000-PIN-RING.75	Rubber for Lamp Wheel	2
	015-PLE-CLRTUBE	Clear Tube	2
	015-PLF-INNERCV	Inner Grill Curved Plastic	2
	015-PLF-INNERST	Inner Grill Straight Plastic	2
	015-PLF-LPILAST	Left Pilaster Plastic	1
	015-PLF-NAMEPLT	Nameplate Plastic	1
	015-PLF-RPILAST	Right Pilaster Plastic	1

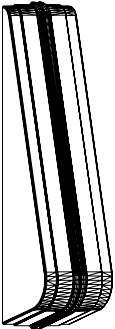
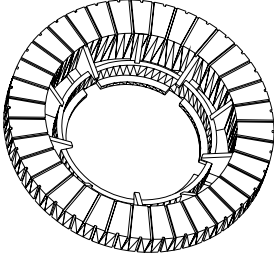
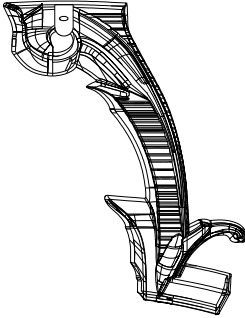
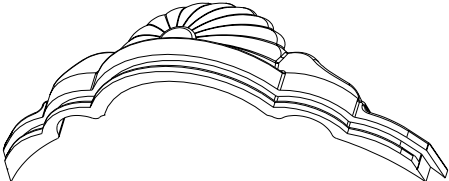
Part Picture	Part Number	Part Name	Qty.
	015-PLF-SIDERED	Side Red Plastic	1
	015-PLF-TOPRED	Top Center Red Plastic	1
	015-PLF-UPLEFT	Upper Left Plastic	1
	015-PLF-UPRIGHT	Upper Right Plastic	1
	015-PLM-CBUTTON	Center Button Casting	2
	015-PLM-COININ	Coin Entry Casting	1
	015-PLM-DRVWHL0	Lamp Drive Wheel	2

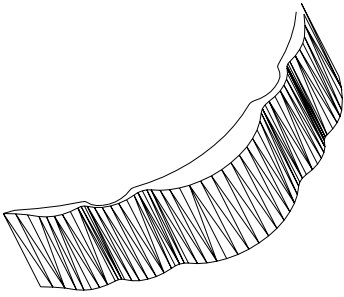
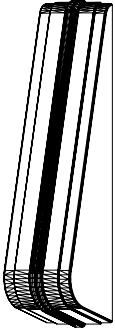
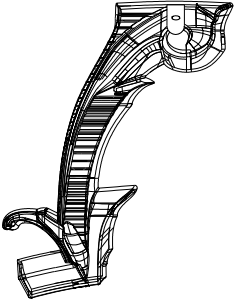
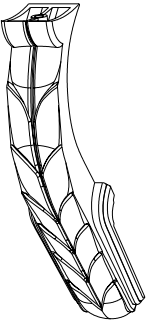
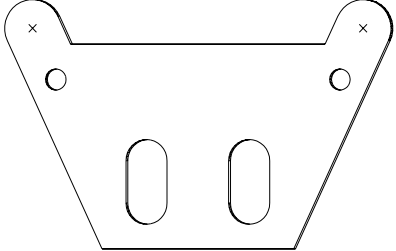
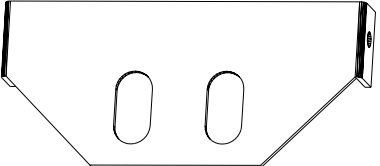
Part Picture	Part Number	Part Name	Qty.
	015-PLM-GRILL	Grill	1
	015-PLM-KEYCAPS	Selector Buttons	12
	015-PLM-LBUTTON	Left Button Casting	
	015-PLM-LMPWHEL	Lamp Wheel	2
	015-PLM-LWCAST	Left W-Casting	1
	015-PLM-PILCAP	Pilaster Trim Cap	2

Part Picture	Part Number	Part Name	Qty.
	015-PLM-PILCAST	Pilaster Trim Casting	6
	015-PLM-RBUTTON	Right Button Casting	
	015-PLM-RWCAST	Right W-Casting	1
	015-PLM-TAIRCST	Tail Casting	1
	015-PLS-BUBSPRT	Bubble Tube Support	4
	015-PLS-BUBTOP	Bubble Tube Top Support	4

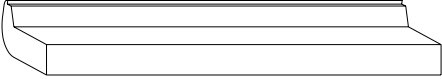
Part Picture	Part Number	Part Name	Qty.
	015-SPK-DRIVER6	6.5" Driver	2
	015-SPK-DRIVE10	10" Woofer	1
	015-SPK-GRCLOTH	Grill Cloth Diamond Pattern	1
	015-SPK-OUTTERM	Speaker Output Terminal	1
	015-SPK-TWEETER	Pioneer Tweeter	2
	015-MSC-BUBINCV	Bubble Tube Inner Curve	2
	015-MSC-BUBOTCV	Bubble Tube Outer Curve	2
	015-MSC-BUBSTRA	Bubble Tube Straight	4

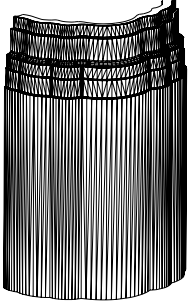
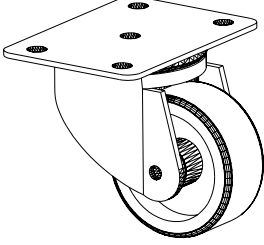
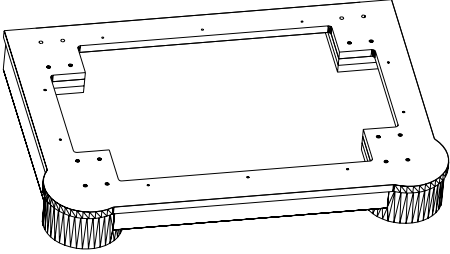
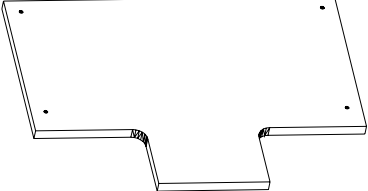
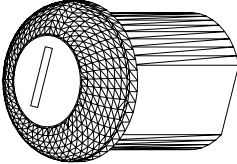
Part Picture	Part Number	Part Name	Qty.
	015-WDM-LCDBOT	Lower Display Molding	3
	015-WDM-LCDBOT	Upper Display Molding	1
	015-WMA-DORCORN	Wood Pilaster Block	2
	000-HDW-3SCASTE	3" Swivel Caster	4
	015-WSA-CABASE	Base Wood	1
	015-WMD-ESHELF	Electronics Shelf	1
	000-LCK-78KY644	7/8" Lock With Key #644	1

13. Wiring Diagram

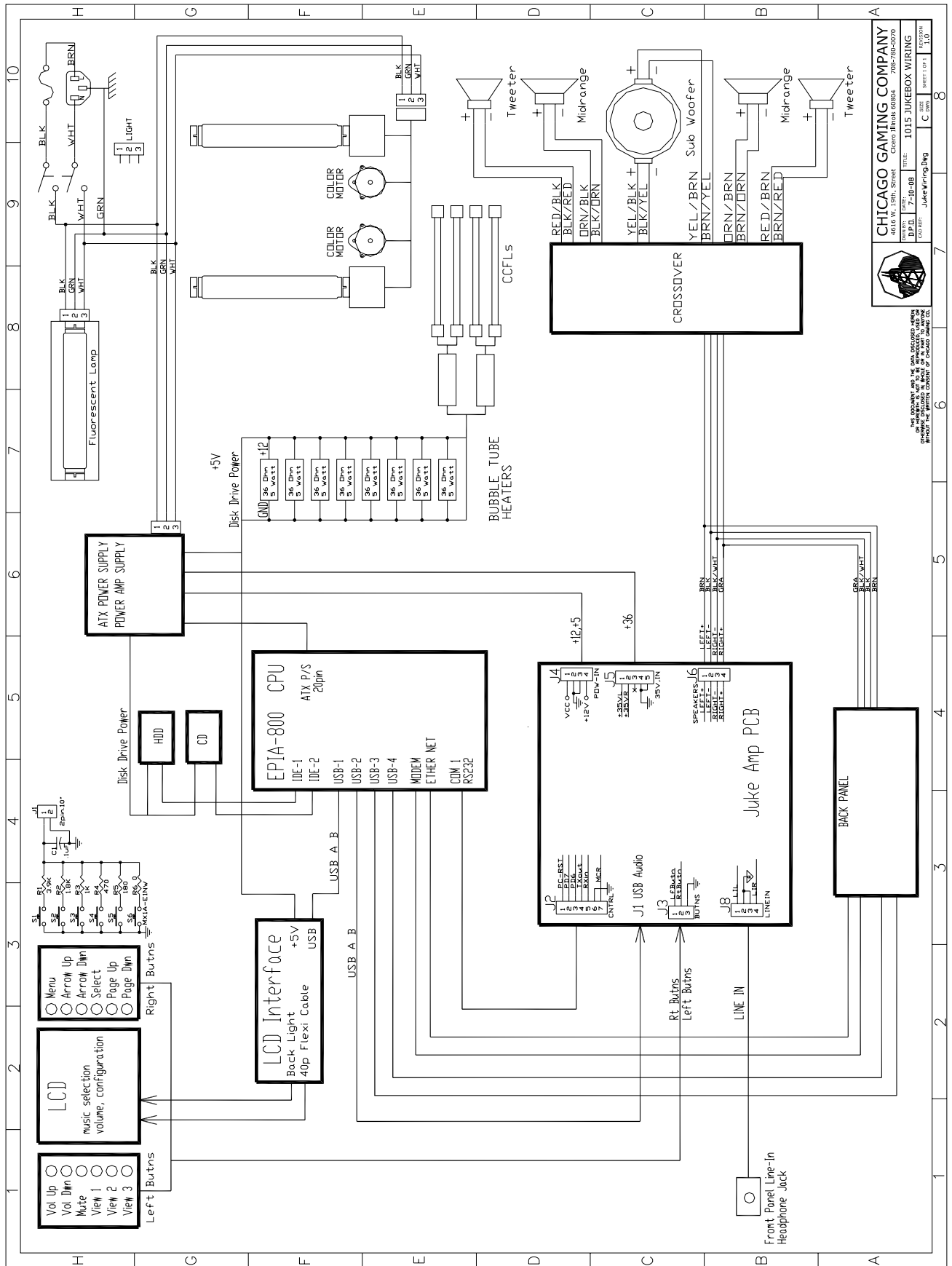

14. FCC COMPLIANCE

Note: This equipment has been tested and found to comply with the limits for a Class B digital device, pursuant to Part 15 of the FCC Rules. These limits are designed to provide reasonable protection against harmful interference in a residential installation. This equipment generates, uses and can radiate radio frequency energy and, if not installed and used in accordance with the instructions, may cause harmful interference to radio communications. However, there is no guarantee that interference will not occur in a particular installation. If this equipment does cause harmful interference to radio or television reception, which can be determined by turning the equipment off and on, the user is encouraged to try to correct the interference by one of more of the following measures:

--Reorient or relocate the receiving antenna.

--Increase the separation between the equipment and receiver.

--Connect the equipment into an outlet on a circuit different from that to which the receiver is connected.

--Consult the dealer or an experienced radio/technician for help.

Changes or modifications not expressly approved in writing by Chicago Gaming Company could void the user's authority to operate the product.

